

# TOUGH GUN® Neck Checking Fixture

## OWNER'S MANUAL

February 2022

**OM-NCF-1.6**

G-405CA (Quick-Change Air-Cooled) and  
GS-101 (Kit, Quick-Change Air-Cooled)

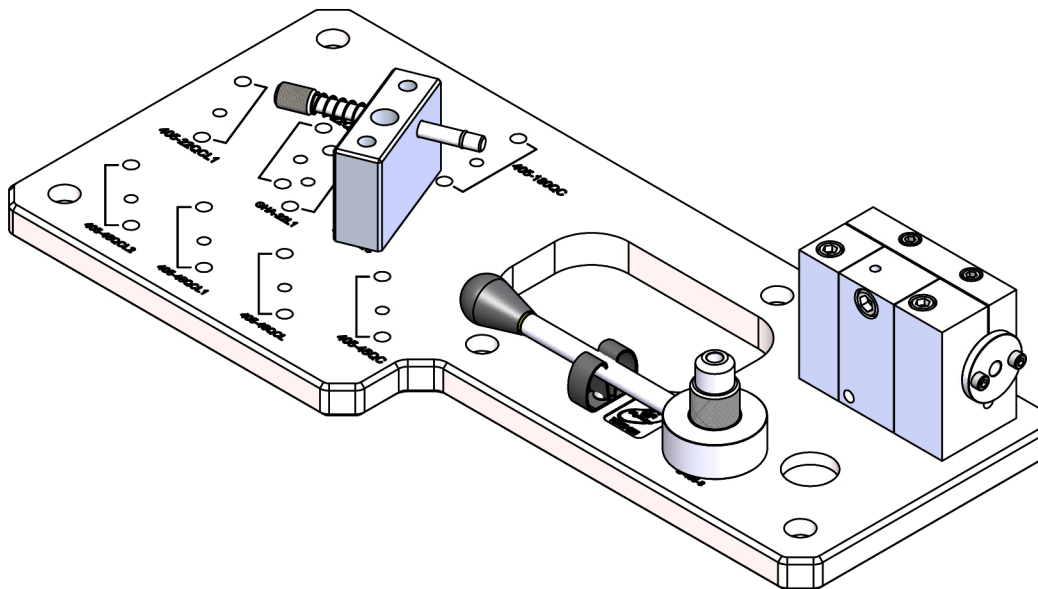

**Tregaskiss.com/TechnicalSupport**  
1-855-MIGWELD (644-9353) (US & Canada)  
+1-519-737-3000 (International)

# Thank You for Choosing Tregaskiss

Thank you for selecting a Tregaskiss product. Before installing, compare the equipment received against the invoice to verify that the shipment is complete and undamaged. It is the responsibility of the purchaser to file all claims of damage or loss that may have occurred during transit with the carrier.

The owner's manual contains general information, instructions and maintenance to help better maintain your MIG gun or peripheral. Please read, understand and follow all safety precautions.

While every precaution has been taken to assure the accuracy of this owner's manual, Tregaskiss assumes no responsibility for errors or omissions. Tregaskiss assumes no liability for damages resulting from the use of information contained herein. The information presented in this owner's manual is accurate to the best of our knowledge at the time of printing. Please reference [Tregaskiss.com](http://Tregaskiss.com) for updated material.

For customer support and special applications, please call the Tregaskiss Customer Service Department at 1-855-MIGWELD (644-9353) (US & Canada) or +1-519-737-3000 (International), fax 1-519-737-1530, or email at [cs@itwmig.com](mailto:cs@itwmig.com). Our trained Customer Service Team is available between 8:00 a.m. and 5:30 p.m. EST, and will answer your product application or repair questions.

Tregaskiss manufactures premium robotic MIG (GMAW) welding guns, peripherals and consumables. For more information on other premium Tregaskiss products, contact your local Tregaskiss distributor or visit us on the web at [Tregaskiss.com](http://Tregaskiss.com).

---

**Subject to Change** – The information presented in this manual is accurate to the best of our knowledge at the time of printing. Please visit [Tregaskiss.com](http://Tregaskiss.com) for the most up-to-date information.

**Additional Material** – For additional support materials such as spec sheets, troubleshooting information, how-to guides and videos, animations, online configurators and much more, please visit [Tregaskiss.com](http://Tregaskiss.com).

Scan this QR Code with your smart phone for immediate access to [Tregaskiss.com/TechnicalSupport](http://Tregaskiss.com/TechnicalSupport)



# TABLE OF CONTENTS

---

<b>SECTION 1 — SAFETY PRECAUTIONS — READ BEFORE USING</b> .....	<b>1</b>
1-1 Symbol Usage .....	1
1-2 Arc Welding Hazards .....	1
1-3 California Proposition 65 Warnings .....	3
1-4 Principal Safety Standards .....	3
1-5 EMF Information .....	3
<b>SECTION 2 — CONSIGNES DE SÉCURITÉ — LIRE AVANT UTILISATION</b> .....	<b>4</b>
2-1 Symboles utilisés .....	4
2-2 Dangers relatifs au soudage à l'arc .....	4
2-3 Proposition californienne 65 avertissements .....	6
2-4 Principales normes de sécurité .....	6
2-5 Informations relatives aux CEM .....	6
<b>SECTION 3 — PRECAUCIONES DE SEGURIDAD — LEA ANTES DE USAR</b> .....	<b>7</b>
3-1 Uso de símbolos .....	7
3-2 Peligros en soldadura de arco .....	7
3-3 Advertencias de la Proposición 65 del estado de California .....	9
3-4 Estándares principales de seguridad .....	9
3-5 Información sobre los campos electromagnéticos (EMF) .....	9
<b>SECTION 4 — PRODUCT WARRANTY</b> .....	<b>10</b>
4-1 Product Warranty .....	10
<b>SECTION 5 — SPECIFICATIONS</b> .....	<b>11</b>
5-1 System Components .....	11
5-2 Checking Fixture by Product Type .....	12
<b>SECTION 6 — OPERATION</b> .....	<b>13</b>
6-1 Using the Neck Checking Fixture .....	13
<b>SECTION 7 — PARTS LIST</b> .....	<b>14</b>
7-1 Checking Fixture Parts List .....	14
7-2 Common Parts to All Checking Fixtures .....	14
<b>ADDITIONAL SUPPORT MATERIALS</b> .....	<b>15</b>

# SECTION 1 — SAFETY PRECAUTIONS — READ BEFORE USING



Protect yourself and others from injury – read, follow, and save these important safety precautions and operating instructions.

## 1-1 Symbol Usage



**DANGER!** – Indicates a hazardous situation which, if not avoided, will result in death or serious injury. The possible hazards are shown in the adjoining symbols or explained in the text.



Indicates a hazardous situation which, if not avoided, could result in death or serious injury. The possible hazards are shown in the adjoining symbols or explained in the text.

**NOTICE** – Indicates statements not related to personal injury.

 – Indicates special instructions.



This group of symbols means Warning! Watch Out! ELECTRIC SHOCK, MOVING PARTS, and HOT PARTS hazards. Consult symbols and related instructions below for necessary actions to avoid the hazards.

## 1-2 Arc Welding Hazards



The symbols shown below are used throughout this manual to call attention to and identify possible hazards. When you see the symbol, watch out, and follow the related instructions to avoid the hazard. The safety information given below is only a summary of the more complete safety information found in section 1-4 Principal Safety Standards on page 3, and in welding power source Owner's Manual. Read and follow all Safety Standards.



Only qualified persons should install, operate, maintain, and repair this equipment. A qualified person is defined as one who, by possession of a recognized degree, certificate, or professional standing, or who by extensive knowledge, training and experience, has successfully demonstrated ability to solve or resolve problems relating to the subject matter, the work, or the project and has received safety training to recognize and avoid the hazards involved.



During operation, keep everybody, especially children, away.

### ELECTRIC SHOCK can kill.

- Always wear dry insulating gloves.
- Insulate yourself from work and ground.
- Do not touch live electrode or electrical parts.



- Replace worn, damaged, or cracked guns or cables.
- Turn off welding power source before changing contact tip or gun parts.
- Keep all covers and handle securely in place.

### FUMES AND GASES can be hazardous.

- Keep your head out of the fumes.
- Ventilate area, or use breathing device. The recommended way to determine adequate ventilation is to sample for the composition and quantity of fumes and gases to which personnel are exposed.
- Read and understand the Safety Data Sheets (SDSs) and the manufacturer's instructions for adhesives, coatings, cleaners, consumables, coolants, degreasers, fluxes, and metals.



### MOVING PARTS can injure.

- Keep away from moving parts.
- Keep away from pinch points such as drive rolls.



### WELDING can cause fire or explosion.

- Do not weld near flammable material.
- Do not weld on containers that have held combustibles, or on closed containers such as tanks, drums, or pipes unless they are properly prepared according to AWS F4.1 and AWS A6.0 (see Safety Standards).
- Watch for fire; keep extinguisher nearby.
- Read and understand the Safety Data Sheets (SDSs) and the manufacturer's instructions for adhesives, coatings, cleaners, consumables, coolants, degreasers, fluxes, and metals.



### BUILDUP OF GAS can injure or kill.

- Shut off compressed gas supply when not in use.
- Always ventilate confined spaces or use approved air-supplied respirator.



### ARC RAYS can burn eyes and skin.

Arc rays from the welding process produce intense visible and invisible (ultraviolet and infrared) rays that can burn eyes and skin. Sparks fly off from the weld.



- Wear an approved welding helmet fitted with a proper shade of filter lenses to protect your face and eyes from arc rays and sparks when welding or watching (see ANSI Z49.1 and Z87.1 listed in Safety Standards).
- Wear approved safety glasses with side shields under your helmet.
- Use protective screens or barriers to protect others from flash, glare and sparks; warn others not to watch the arc.
- Wear body protection made from leather or flame-resistant clothing (FRC). Body protection includes oil-free clothing such as leather gloves, heavy shirt, cuffless trousers, high shoes, and a cap.

### **HOT PARTS can burn.**

- Allow gun to cool before touching.
- Do not touch hot metal.
- Protect hot metal from contact by others.



### **NOISE can damage hearing.**

Noise from some processes or equipment can damage hearing.



- Check for noise level limits exceeding those specified by OSHA.
- Use approved ear plugs or ear muffs if noise level is high.
- Warn others nearby about noise hazard.

### **WELDING WIRE can injure.**

- Keep hands and body away from gun tip when trigger is pressed.



### **READ INSTRUCTIONS.**

- Read and follow all labels and the Owner's Manual carefully before installing, operating, or servicing unit. Read the safety information at the beginning of the Manual and in each section.
- Use only genuine replacement parts from the manufacturer.
- Perform installation, maintenance, and service according to the Owner's Manuals, industry standards, and national, state, and local codes.

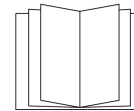

## 1-3 California Proposition 65 Warnings



**WARNING:** This product can expose you to chemicals including lead, which are known to the state of California to cause cancer and birth defects or other reproductive harm.

For more information, go to [www.P65Warnings.ca.gov](http://www.P65Warnings.ca.gov).

## 1-4 Principal Safety Standards

*Safety in Welding, Cutting, and Allied Processes*, American Welding Society standard ANSI Standard Z49.1. Website: [www.aws.org](http://www.aws.org).

*Safe Practice For Occupational And Educational Eye And Face Protection*, ANSI Standard Z87.1, from American National Standards Institute. Website: [www.ansi.org](http://www.ansi.org).

*Safe Practices for the Preparation of Containers and Piping for Welding and Cutting*, American Welding Society Standard AWS F4.1. Website: [www.aws.org](http://www.aws.org).

*National Electrical Code*, NFPA Standard 70 from National Fire Protection Association. Website: [www.nfpa.org](http://www.nfpa.org).

*Safe Handling of Compressed Gases in Cylinders*, CGA Pamphlet P-1 from Compressed Gas Association. Website: [www.cganet.com](http://www.cganet.com).

*Safety in Welding, Cutting, and Allied Processes*, CSA Standard W117.2 from Canadian Standards Association. Website: [www.csagroup.org](http://www.csagroup.org).

*Standard for Fire Prevention During Welding, Cutting, and Other Hot Work*, NFPA Standard 51B from National Fire Protection Association. Website: [www.nfpa.org](http://www.nfpa.org).

OSHA, Occupational Safety and Health Standards for General Industry, Title 29, Code of Federal Regulations (CFR), Part 1910.177 Subpart N, Part 1910 Subpart Q, and Part 1926, Subpart J. Website: [www.osha.gov](http://www.osha.gov).

SR7 2022-01

## 1-5 EMF Information

Electric current flowing through any conductor causes localized electric and magnetic fields (EMF). The current from arc welding (and allied processes including spot welding, gouging, plasma arc cutting, and induction heating operations) creates an EMF field around the welding circuit. EMF fields may interfere with some medical implants, e.g. Pacemakers. Protective measures for persons wearing medical implants have to be taken. For example, restrict access for passersby or conduct individual risk assessment for welders. All welders should use the following procedures in order to minimize exposure to EMF fields from the welding circuit:

1. Keep cables close together by twisting or taping them, or using a cable cover.
2. Do not place your body between welding cables. Arrange cables to one side and away from the operator.

3. Do not coil or drape cables around your body.
4. Keep head and trunk as far away from the equipment in the welding circuit as possible.
5. Connect work clamp to workpiece as close to the weld as possible.
6. Do not work next to, sit or lean on the welding power source.
7. Do not weld whilst carrying the welding power source wire feeder.

### **About Implanted Medical Devices:**

Implanted Medical Device wearers should consult their doctor and the device manufacturer before performing or going near arc welding, spot welding, gouging, plasma arc cutting, or induction heating operations. If cleared by your doctor, then following the above procedures is recommended.

## SECTION 2 — CONSIGNES DE SÉCURITÉ — LIRE AVANT UTILISATION

 Pour écarter les risques de blessure pour vous-même et pour autrui — lire, appliquer et ranger en lieu sûr ces consignes relatives aux précautions de sécurité et au mode opératoire.

### 2-1 Symboles utilisés

 **DANGER!** – Indique une situation dangereuse qui si on l'évite pas peut donner la mort ou des blessures graves. Les dangers possibles sont montrés par les symboles joints ou sont expliqués dans le texte.

 Indique une situation dangereuse qui si on l'évite pas peut donner la mort ou des blessures graves. Les dangers possibles sont montrés par les symboles joints ou sont expliqués dans le texte.

*AVIS* – Indique des déclarations pas en relation avec des blessures personnelles.

 – Indique des instructions spécifiques.



Ce groupe de symboles veut dire Avertissement! Attention! DANGER DE CHOC ELECTRIQUE, PIECES EN MOUVEMENT, et PIECES CHAUDES. Reportez-vous aux symboles et aux directives ci-dessous afin de connaître les mesures à prendre pour éviter tout danger.

### 2-2 Dangers relatifs au soudage à l'arc

 Les symboles donnés ci-après sont utilisés dans tout le manuel pour attirer l'attention sur les dangers possibles et pour indiquer le type de danger dont il s'agit. Quand on voit le symbole, prendre garde et suivre les directives correspondantes pour éviter le danger. Les consignes de sécurité présentées ci-après ne font que résumer l'information contenue dans les Normes de sécurité principales, et dans le Guide d'utilisation de la source de courant de soudage. Lire et suivre toutes les Normes de sécurité.

 L'installation, l'utilisation, l'entretien et les réparations ne doivent être confiés qu'à des personnes qualifiées. Une personne qualifiée est définie comme celle qui, par la possession d'un diplôme reconnu, d'un certificat ou d'un statut professionnel, ou qui, par une connaissance, une formation et une expérience approfondies, a démontré avec succès sa capacité à résoudre les problèmes liés à la tâche, le travail ou le projet et a reçu une formation en sécurité afin de reconnaître et d'éviter les risques inhérents.

 Au cours de l'utilisation, tenir toute personne à l'écart et plus particulièrement les enfants.

### UN CHOC ÉLECTRIQUE peut tuer.



- Porter toujours des gants secs et isolants.
- S'isoler de la pièce et de la terre.
- Ne jamais toucher une électrode ou des pièces électriques sous tension.
- Remplacer les pistolets ou câbles de soudage qui sont endommagés, usés ou craquelés.
- Mettre la soudeuse hors tension avant de remplacer un bec contact ou des pièces de pistolet.
- S'assurer que tous les couvercles et poignées sont fermement assujettis.

### LES FUMÉES ET LES GAZ peuvent être dangereux.



- Garder la tête hors des fumées.
- Aérer la zone de travail ou porter un appareil respiratoire. Pour déterminer la bonne ventilation, il est recommandé de procéder à un prélèvement pour la composition et la quantité de fumées et de gaz auxquels est exposé le personnel.
- Lire et comprendre les fiches de données de sécurité et les instructions du fabricant concernant les adhésifs, les revêtements, les nettoyants, les consommables, les produits de refroidissement, les dégraissants, les flux et les métaux.

### Les PIÈCES MOBILES peuvent causer des blessures.



- Ne pas s'approcher des organes mobiles.
- Ne pas s'approcher des points de coincement tels que des rouleaux de commande.

### Le SOUDAGE peut provoquer un incendie ou une explosion.



- Ne pas souder à proximité de matériaux inflammables
- Ne pas effectuer le soudage sur des conteneurs fermés tels que des réservoirs, tambours, ou conduites, à moins qu'ils n'aient été préparés correctement conformément à AWS F4.1 et AWS A6.0 (voir les Normes de Sécurité).
- Prendre garde aux incendies et toujours avoir un extincteur à proximité.

- Lire et comprendre les fiches de données de sécurité et les instructions du fabricant concernant les adhésifs, les revêtements, les nettoyants, les consommables, les produits de refroidissement, les dégraissateurs, les flux et les métaux.

### L'ACCUMULATION DE GAZ risquent de provoquer des blessures ou même la mort.



- Fermer l'alimentation du gaz comprimé en cas de non utilisation.
- Veiller toujours à bien aérer les espaces confinés ou se servir d'un respirateur d'adduction d'air homologué.

### LE RAYONNEMENT DE L'ARC peut brûler les yeux et la peau.



Le rayonnement de l'arc du procédé de soudage génère des rayons visibles et invisibles intenses (ultraviolets et infrarouges) susceptibles de provoquer des brûlures dans les yeux et sur la peau. Des étincelles sont projetées pendant le soudage.

- Porter un casque de soudage approuvé muni de verres filtrants approprié pour protéger visage et yeux pendant le soudage (voir ANSI Z49.1 et Z87.1 énuméré dans les normes de sécurité).
- Porter des lunettes de sécurité avec écrans latéraux même sous votre casque.
- Avoir recours à des écrans protecteurs ou à des rideaux pour protéger les autres contre les rayonnements les éblouissements et les étincelles ; prévenir toute personne sur les lieux de ne pas regarder l'arc.
- Porter une protection corporelle en cuir ou des vêtements ignifuges (FRC). La protection du corps comporte des vêtements sans huile, comme des gants de cuir, une chemise solide, des pantalons sans revers, des chaussures hautes et une casquette.

### LES PIÈCES CHAUDES peuvent provoquer des brûlures.



- Laisser refroidir le pistolet avant de le toucher.
- Ne pas toucher d'objets métalliques chauds.
- Abrisser les objets métalliques contre tout contact par les personnes à proximité.

### Le BRUIT peut endommager l'ouïe.

Le bruit des processus et des équipements peut affecter l'ouïe.



- Vérifier si les niveaux de bruit excèdent les limites spécifiées par l'OSHA.
- Utiliser des bouches-oreilles ou des serre-tête antibruit approuvés si le niveau de bruit est élevé.

- Avertir les personnes à proximité au sujet du danger inhérent au bruit.

### LES FILS DE SOUDAGE peuvent provoquer des blessures.



- Éloigner les mains et le corps de la buse du pistolet après avoir appuyé sur la gâchette.

### LIRE LES INSTRUCTIONS.

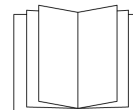

- Lire et appliquer les instructions sur les étiquettes et le Mode d'emploi avant l'installation, l'utilisation ou l'entretien de l'appareil. Lire les informations de sécurité au début du manuel et dans chaque section.
- N'utiliser que les pièces de remplacement provenant du fabricant.
- Effectuer l'installation, l'entretien et toute intervention selon les manuels d'utilisateurs, les normes nationales, provinciales et de l'industrie, ainsi que les codes municipaux.



## 2-3 Proposition californienne 65 avertissements



**AVERTISSEMENT** – Ce produit peut vous exposer à des produits chimiques tels que le plomb, reconnus par l'État de Californie comme cancérigènes et sources de malformations ou d'autres troubles de la reproduction

Pour plus d'informations, consulter [www.P65Warnings.ca.gov](http://www.P65Warnings.ca.gov).

## 2-4 Principales normes de sécurité

*Safety in Welding, Cutting, and Allied Processes*, American Welding Society standard ANSI Standard Z49.1. Website: [www.aws.org](http://www.aws.org).

*Safe Practice For Occupational And Educational Eye And Face Protection*, ANSI Standard Z87.1, from American National Standards Institute. Website: [www.ansi.org](http://www.ansi.org).

*Safe Practices for the Preparation of Containers and Piping for Welding and Cutting*, American Welding Society Standard AWS F4.1 from Global Engineering Documents. Website: [www.aws.org](http://www.aws.org).

*National Electrical Code*, NFPA Standard 70 from National Fire Protection Association. Website: [www.nfpa.org](http://www.nfpa.org).

*Safe Handling of Compressed Gases in Cylinders*, CGA Pamphlet P-1 from Compressed Gas Association. Website: [www.cganet.com](http://www.cganet.com).

*Safety in Welding, Cutting, and Allied Processes*, CSA Standard W117.2 from Canadian Standards Association. Website: [www.csagroup.org](http://www.csagroup.org).

*Standard for Fire Prevention During Welding, Cutting, and Other Hot Work*, NFPA Standard 51B from National Fire Protection Association. Website: [www.nfpa.org](http://www.nfpa.org).

OSHA, Occupational Safety and Health Standards for General Industry, Title 29, Code of Federal Regulations (CFR), Part 1910.177 Subpart N, Part 1910 Subpart Q, and Part 1926, Subpart J. Website: [www.osha.gov](http://www.osha.gov).

SR7\_fre 2022-01

## 2-5 Informations relatives aux CEM

Le courant électrique qui traverse tout conducteur génère des champs électromagnétiques (CEM) à certains endroits. Le courant issu d'un soudage à l'arc (et de procédés connexes, y compris le soudage par points, le gougeage, le découpage plasma et les opérations de chauffage par induction) crée un champ électromagnétique (CEM) autour du circuit de soudage. Les champs électromagnétiques produits peuvent causer interférence à certains implants médicaux, p. ex. les stimulateurs cardiaques. Des mesures de protection pour les porteurs d'implants médicaux doivent être prises: par exemple, des restrictions d'accès pour les passants ou une évaluation individuelle des risques pour les soudeurs. Tous les soudeurs doivent appliquer les procédures suivantes pour minimiser l'exposition aux CEM provenant du circuit de soudage:

1. Rassembler les câbles en les torsadant ou en les attachant avec du ruban adhésif ou avec une housse.
2. Ne pas se tenir au milieu des câbles de soudage. Disposer les câbles d'un côté et à distance de l'opérateur.

3. Ne pas courber et ne pas entourer les câbles autour de votre corps.
4. Maintenir la tête et le torse aussi loin que possible du matériel du circuit de soudage.
5. Connecter la pince sur la pièce aussi près que possible de la soudure.
6. Ne pas travailler à proximité d'une source de soudage, ni s'asseoir ou se pencher dessus.
7. Ne pas souder tout en portant la source de soudage ou le dévidoir.

### En ce qui concerne les implants médicaux :

Les porteurs d'implants doivent d'abord consulter leur médecin avant de s'approcher des opérations de soudage à l'arc, de soudage par points, de gougeage, du coupage plasma ou de chauffage par induction. Si le médecin approuve, il est recommandé de suivre les procédures précédentes.

## SECTION 3 — PRECAUCIONES DE SEGURIDAD — LEA ANTES DE USAR

 **Protéjase usted mismo y a otros contra lesiones — lea, cumpla y conserve estas importantes precauciones de seguridad e instrucciones de utilización.**

### 3-1 Uso de símbolos

 **PELIGRO!** – Indica una situación peligrosa que, si no se la evita, resultará en muerte o lesión grave. Los peligros posibles se muestran en los símbolos adjuntos o se explican en el texto.

 Indica una situación peligrosa que, si no se la evita, podría resultar en muerte o lesión grave. Los peligros posibles se muestran en los símbolos adjuntos, o se explican en el texto.

**AVISO** – Indica precauciones no relacionadas a lesiones personales.

 – Indica instrucciones especiales.



Este grupo de símbolos significa ¡Advertencia!, ¡Cuidado! CHOQUE O DESCARGA ELÉCTRICA, PIEZAS QUE SE MUEVEN, y peligros de PARTES CALIENTES. Consulte los símbolos y las instrucciones relacionadas que aparecen a continuación para ver las acciones necesarias para evitar estos peligros.

### 3-2 Peligros en soldadura de arco

 Los símbolos mostrados abajo se usan en todo este manual para llamar la atención a e identificar los posibles peligros. Cuando vea el símbolo, preste atención y siga las instrucciones relacionadas para evitar el peligro. La información de seguridad dada abajo es solamente un resumen de la información más completa de seguridad que se encuentra en los estándares de seguridad, y la fuente de alimentación para soldadura del Manual del usuario. Lea y siga todas las normas de seguridad.

 Solamente personal cualificado debe instalar, utilizar, mantener y reparar este equipo. La definición de personal cualificado es cualquier persona que, debido a que posee un título, un certificado o una posición profesional reconocida, o gracias a su gran conocimiento, capacitación y experiencia, haya demostrado con éxito la capacidad para solucionar o resolver problemas relacionados con el trabajo, el proyecto o el tema en cuestión, además de haber asistido a una capacitación en seguridad para reconocer y evitar los peligros que implica el proceso.

 Durante su operación mantenga lejos a todos, especialmente a los niños.

**UNA DESCARGA ELÉCTRICA puede matarlo.**



- Siempre use guantes aislantes secos.
- Aíslese usted mismo del trabajo y la tierra.
- No toque electrodo eléctricamente vivo o partes eléctricamente vivas.
- Reemplace antorchas o cables desgastados, dañados o rotos.
- Repare o reemplace aislamiento de la pistola o del cable que esté desgastado, dañado o agrietado.
- Apague la máquina de soldar antes de cambiar los tubos de contacto o piezas de la antorcha.
- Mantenga todas las tapas y asa bien seguras en sitio.

**HUMO y GASES pueden ser peligrosos.**



- Mantenga su cabeza fuera del humo.
- Ventile el lugar o use un aparato para respirar. El método recomendado para determinar la ventilación adecuada es tomar muestras de la composición y cantidad de humos y gases a los que está expuesto el personal.
- Lea y entienda las Hojas de datos del material (SDS) y las instrucciones del fabricante relacionadas con los adhesivos, metales, consumibles, recubrimientos, limpiadores, refrigerantes, desengrasadores, fundentes y metales.

**Las PIEZAS MÓVILES pueden provocar lesiones.**



- Aléjese de toda parte en movimiento.
- Aléjese de todo punto que pellizque, tal como rodillos impulsados.

**EL SOLDAR puede causar fuego o explosión.**



- No suelde cerca de material inflamable
- No suelde en recipientes que han contenido combustibles, ni en recipientes cerrados como tanques, tambores o tuberías, a menos que estén preparados correctamente de acuerdo con la norma AWS F4.1 y AWS A6.0 (vea las normas de seguridad).
- Siempre mire que no haya fuego y mantenga un extinguidor de fuego cerca.
- Lea y entienda las Hojas de datos del material (SDS) y las instrucciones del fabricante relacionadas con los adhesivos, metales, consumibles, recubrimientos, limpiadores, refrigerantes, desengrasadores, fundentes y metales.

## EL AMONTONAMIENTO DE GAS puede enfermarle o matarle.



- Cierre el suministro de gas comprimido cuando no lo use.
- Siempre dé ventilación a espacios cerrados o use un respirador aprobado que reemplaza el aire.

## LOS RAYOS DEL ARCO pueden quemar sus ojos y piel.



Los rayos del arco de un proceso de suelda producen un calor intenso y rayos ultravioletas fuertes que pueden quemar los ojos y la piel. Las chispas se escapan de la soldadura.

- Use una careta para soldar aprobada equipada con un filtro de protección apropiado para proteger su cara y ojos de los rayos del arco y de las chispas mientras esté soldando o mirando. (véase los estándares de seguridad ANSI Z49.1 y Z87.1).
- Use anteojos de seguridad aprobados que tengan protección lateral.
- Use pantallas de protección o barreras para proteger a otros del destello, reflejos y chispas, alerte a otros que no miren el arco.
- Use protección para el cuerpo hecha de cuero o de prendas resistentes a las llamas (FRC). Entre la protección para el cuerpo se incluye la ropa sin aceite, como guantes de cuero, una camisa gruesa, pantalones sin vuelta, calzado alto y una gorra.

## PARTES CALIENTES puedan causar quemaduras severas.



- Permita que la antorcha se enfríe antes de tocarla.
- No toque metal caliente.
- Proteja a otros del contacto con el metal caliente.

## EL RUIDO puede trastornar su oído.



Ruido proveniente de algunos procesos o equipo puede dañar el oído.

- Chequee los límites del nivel del ruido si exceden aquellos especificados por OSHA.
- Use tapas para los oídos o cubiertas para los oídos si el nivel del ruido es demasiado alto.
- Advierta a otros que estén cerca acerca del peligro del ruido.

## El ALAMBRE de SOLDAR puede causarle heridas.



- Mantenga las manos y el cuerpo lejos del tubo de contacto de la antorcha cuando se haya presionado el gatillo.

## LEER INSTRUCCIONES.

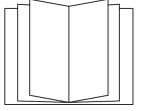

- Lea y siga cuidadosamente las instrucciones contenidas en todas las etiquetas y en el Manual del usuario antes de instalar, utilizar o realizar tareas de mantenimiento en la unidad. Lea la información de seguridad incluida en la primera parte del manual y en cada sección.
- Utilice únicamente piezas de reemplazo legítimas del fabricante.
- Los trabajos de instalación y mantenimiento deben ser ejecutados de acuerdo con las instrucciones del manual del usuario, las normas del sector y los códigos nacionales, estatales y locales.

### 3-3 Advertencias de la Proposición 65 del estado de California



**ADVERTENCIA:** Este producto puede exponerlo a químicos, incluso plomo, que el estado de California conoce como causantes de cáncer, defectos de nacimiento u otros daños reproductivos.

Para obtener más información, acceda a [www.P65Warnings.ca.gov](http://www.P65Warnings.ca.gov).

### 3-4 Estándares principales de seguridad

*Safety in Welding, Cutting, and Allied Processes*, American Welding Society standard ANSI Standard Z49.1. Website: [www.aws.org](http://www.aws.org).

*Safe Practice For Occupational And Educational Eye And Face Protection*, ANSI Standard Z87.1, from American National Standards Institute. Website: [www.ansi.org](http://www.ansi.org).

*Safe Practices for the Preparation of Containers and Piping for Welding and Cutting*, American Welding Society Standard AWS F4.1 from Global Engineering Documents. Website: [www.aws.org](http://www.aws.org).

*National Electrical Code*, NFPA Standard 70 from National Fire Protection Association. Website: [www.nfpa.org](http://www.nfpa.org).

*Safe Handling of Compressed Gases in Cylinders*, CGA Pamphlet P-1 from Compressed Gas Association. Website: [www.cganet.com](http://www.cganet.com).

*Safety in Welding, Cutting, and Allied Processes*, CSA Standard W117.2 from Canadian Standards Association. Website: [www.csagroup.org](http://www.csagroup.org).

*Standard for Fire Prevention During Welding, Cutting, and Other Hot Work*, NFPA Standard 51B from National Fire Protection Association. Website: [www.nfpa.org](http://www.nfpa.org).

OSHA, Occupational Safety and Health Standards for General Industry, Title 29, Code of Federal Regulations (CFR), Part 1910.177 Subpart N, Part 1910 Subpart Q, and Part 1926, Subpart J. Website: [www.osha.gov](http://www.osha.gov).

SR7\_spa 2022-01

### 3-5 Información sobre los campos electromagnéticos (EMF)

La corriente que fluye a través de un conductor genera campos eléctricos y magnéticos (EMF) localizados. La corriente del arco de soldadura (y otras técnicas afines como la soldadura por puntos, el ranurado, el corte por plasma y el calentamiento por inducción) genera un campo EMF alrededor del circuito de soldadura. Los campos EMF pueden interferir con algunos dispositivos médicos implantados como, por ejemplo, los marcapasos. Por lo tanto, se deben tomar medidas de protección para las personas que utilizan estos implantes médicos. Por ejemplo, aplique restricciones al acceso de personas que pasan por las cercanías o realice evaluaciones de riesgo individuales para los soldadores. Todos los soldadores deben seguir los procedimientos que se indican a continuación con el objeto de minimizar la exposición a los campos EMF generados por el circuito de soldadura:

1. Mantenga los cables juntos retorciéndolos entre sí o uniéndolos mediante cintas o una cubierta para cables.
2. No ubique su cuerpo entre los cables de soldadura. Disponga los cables a un lado y apártelos del operario.

3. No enrolle ni cuelgue los cables sobre su cuerpo.
4. Mantenga la cabeza y el tronco tan apartados del equipo del circuito de soldadura como le sea posible.
5. Conecte la pinza de masa en la pieza lo más cerca posible de la soldadura.
6. No trabaje cerca de la fuente de alimentación para soldadura, ni se siente o recueste sobre ella.
7. No suelde mientras transporta la fuente de alimentación o el alimentador de alambre.

#### **Acerca de los aparatos médicos implantados:**

Las personas que usen aparatos médico implantados deben consultar con su médico y el fabricante del aparato antes de llevar a cabo o acercarse a soldadura de arco, soldadura de punto, ranurar, hacer corte por plasma, u operaciones de calentamiento por inducción. Si su doctor lo permite, entonces siga los procedimientos de arriba.

# SECTION 4 — PRODUCT WARRANTY

## 4-1 Product Warranty

### Limited Warranty

Tregaskiss' Products shall, from the date of original purchase (or, solely with respect to Low Stress Robotic Unicables packaged with any Tregaskiss® Robotic MIG Gun, from the date the product goes into production for its intended use) and for the period set forth below, be free from defects in material and workmanship. To obtain repair or replacement of any Product, the covered Product must be delivered, transportation pre-paid by Purchaser, to the address specified by Tregaskiss on its Returned Materials Authorization, with: (i) written proof of warranty coverage (e.g., Purchaser dated purchase order); (ii) serial number on product (if any); (iii) the Product's installed location within Purchaser's facility and usage of the Product; and (iv) written specification of any alleged defect(s). In the event the foregoing materials are not timely provided to Tregaskiss by claimant, warranty coverage will be determined by Tregaskiss, in its sole discretion. For the avoidance of doubt, the warranty period for any Product or part/component of any Product that is replaced or repaired by Tregaskiss under the foregoing warranty is not extended or renewed at the time of such replacement or repair. **The Warranty against defects does not apply to: (1) consumable components or ordinary wear items; (2) products which are improperly altered, modified, stored, installed, operated, handled, used or neglected or use of the Products with equipment, components or parts not specified or supplied by Tregaskiss or contemplated under the Product documentation; or (3) Products which have not been operated, maintained, and repaired pursuant to Product documentation provided by Tregaskiss. Purchaser shall pay Tregaskiss for all warranty claim costs incurred by Tregaskiss (including inspection, labor, parts, testing, scrap and freight) due to warranty claims submitted by Purchaser which are not covered by Tregaskiss' warranty.**

- Bernard® BTB Semi-Automatic Air-Cooled MIG Guns: **1 year**; *Lifetime warranty on straight handles, straight handle switches, and rear strain relief*
- Bernard® W-Gun™ and T-Gun™ Semi-Automatic Water-Cooled MIG Guns: **180 days**
- Bernard® TGX® Chassis and Bernard TGX Ready To Weld MIG Guns: **90 days**
- Tregaskiss® Robotic MIG Guns and Components: **1 year**
- Tregaskiss® Automatic MIG Guns: **1 year**
- Tregaskiss® TOUGH GUN® Reamer:
  - When factory-equipped with lubricator: **2 years** when factory-equipped with lubricator
  - When (i) factory-equipped with lubricator and (ii) used exclusively with Tregaskiss® TOUGH GARD® Anti-Spatter Liquid: **3 years** when both (i) and (ii)
- Tregaskiss® TOUGH GUN® Robotic Peripheral (Clutch, Sprayer, Wire Cutter, Arms): **1 year**
- Tregaskiss® Low-Stress Robotic Unicables (LSR Unicables): **6 months**

### Service Warranty

Tregaskiss warrants the Services shall conform to any mutually agreed upon specifications or statements of work. Purchaser's sole remedy, and Tregaskiss's sole liability, for a breach of the foregoing warranty is for Tregaskiss, at its option, to re-perform the Services or credit Purchaser's account for such Services.

### Limitation of Liability and Remedies

TREGASKISS WILL NOT BE LIABLE, AND PURCHASER WAIVES ALL CLAIMS AGAINST TREGASKISS FOR INDIRECT, INCIDENTAL, SPECIAL, PUNITIVE OR CONSEQUENTIAL DAMAGES, DOWN TIME, LOST PROFITS OR COMMERCIAL LOSSES, WHETHER OR NOT BASED UPON TREGASKISS' NEGLIGENCE OR BREACH OF WARRANTY OR STRICT LIABILITY IN TORT OR ANY OTHER CAUSE OF ACTION. IN NO EVENT WILL TREGASKISS' LIABILITY IN CONNECTION WITH THE AGREEMENT OR SALE OF TREGASKISS' PRODUCTS OR SERVICES EXCEED THE PURCHASE PRICE OF THE SPECIFIC PRODUCTS OR SERVICES AS TO WHICH THE CLAIM IS MADE.

# SECTION 5 — SPECIFICATIONS

## 5-1 System Components

### A. G-405CA Neck Checking Fixture for Quick-Change Air-Cooled and TOUGH GUN I.C.E.® Necks

<b>22 Degree</b>	<b>Air-Cooled Neck</b>	<b>TOUGH GUN I.C.E.® Neck</b>
Short length	405-22QC	590-22-x.xxx*
Medium length	405-22QCL	590-22L-x.xxx*
Long length	405-22QCL1	590-22L1-x.xxx*
<b>45 Degree</b>	<b>Air-Cooled Neck</b>	<b>TOUGH GUN I.C.E. Neck</b>
Short length	405-45QC	590-45-x.xxx*
Medium length	405-45QCL	590-45L-x.xxx*
Long length	405-45QCL1	590-45L1-x.xxx*
Extended length	405-45QCL2	590-45L2-x.xxx*
<b>180 Degree</b>	<b>Air-Cooled Neck</b>	<b>TOUGH GUN I.C.E. Neck</b>
Short length	405-180QC	590-180-x.xxx*

\* x.xxx represents nozzle O.D. (i.e. 590-45L-1.060)

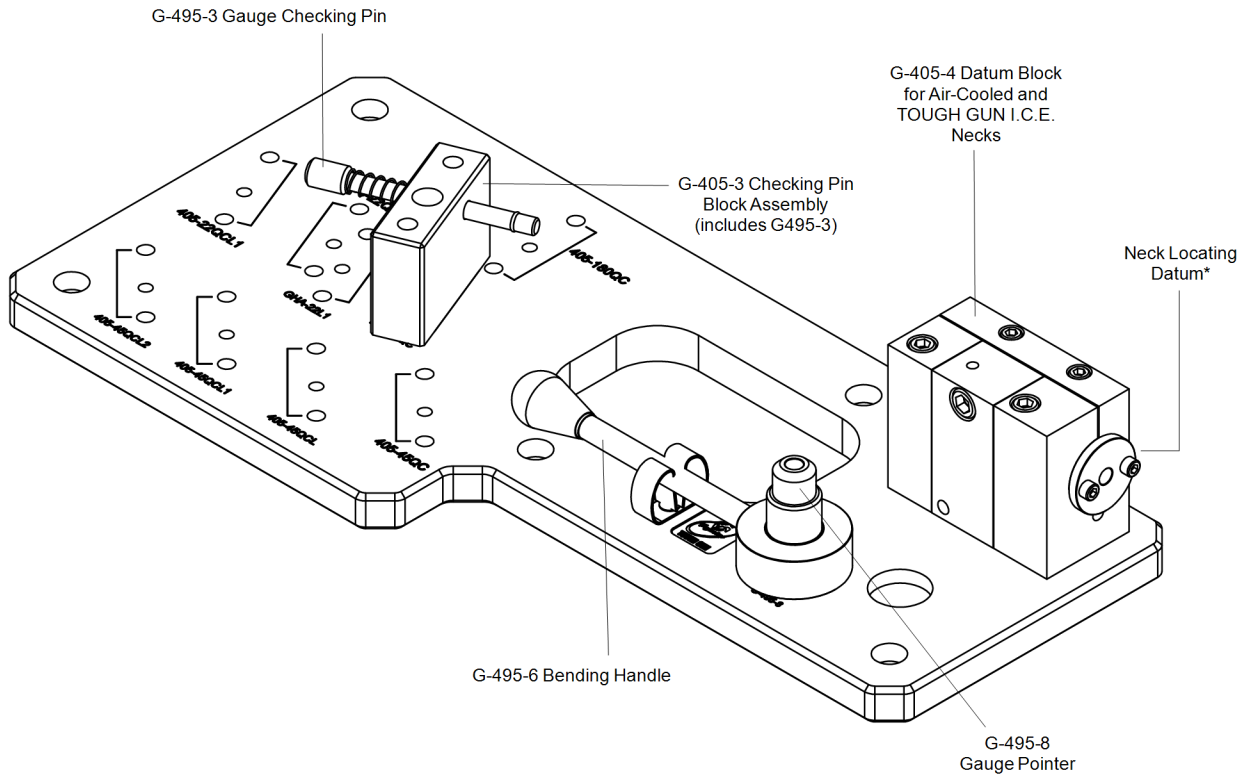

**\*IMPORTANT:**

The neck locating datum **MUST** be installed properly before operating the fixture! **DO NOT** operate the fixture without the neck locating datum being installed properly.

## B. G-495-8 Gauge Pointer

Required for all neck checking fixtures

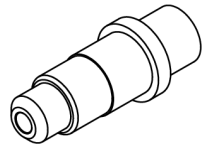

## C. GS-101 Kit

For Special Air-Cooled Necks (includes all parts from G-405CA except base plate)

**NOTE:** *Prints* to manufacture base plates for Special necks will be supplied upon request

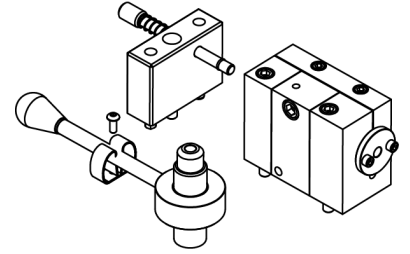

## 5-2 Checking Fixture by Product Type

Product Type	Checking Fixture Part Number (TOUGH GUN CA3 Series)
Quick-Change Air-Cooled	G-405CA
TOUGH GUN I.C.E. Neck	G-405CA

# SECTION 6 — OPERATION

## 6-1 Using the Neck Checking Fixture

### Instructions for G-405CA (other fixtures similar)

1. Remove front-end consumables (nozzle, retaining head, and neck insulator), with the exception of TOUGH GUN I.C.E. Components.
2. Install the gauge point into the neck.
3. Slide neck completely into the datum block, aligning keys on neck to keyway in datum block.
4. Turn the neck completely clockwise against shoulder.
5. To secure the neck, use a 5/16" Allen key to tighten the socket head cap screw (SHCS) on the front of the datum block.
6. Push check pin towards gauge point.
7. Check pin should insert into the mating hole on gauge point.
8. Slip bending handle onto gauge point and bend until aligned with check pin.
9. Remove neck from datum block and gauge point from neck.
10. Reinstall front-end consumables.

Figure 6-A

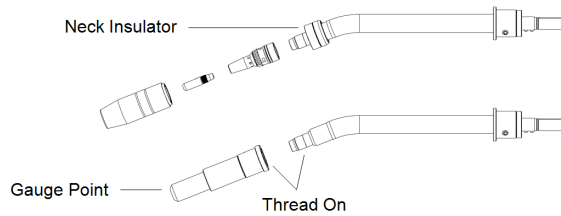

Figure 6-B

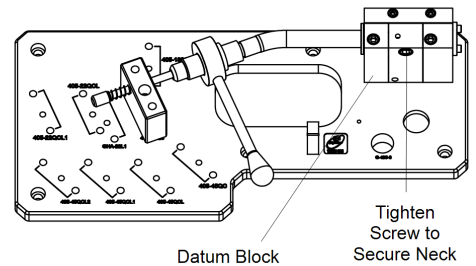

Figure 6-C

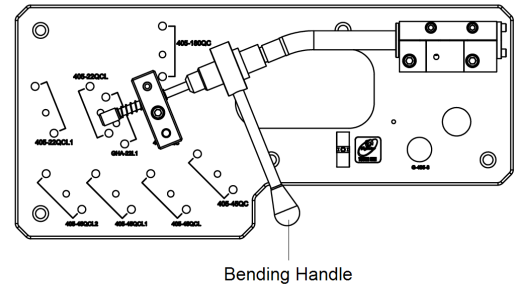
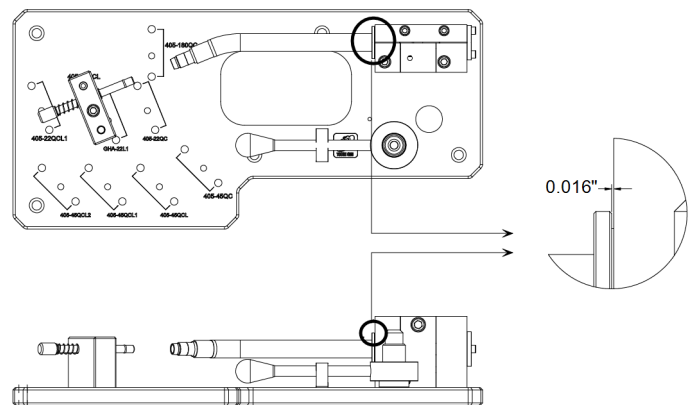

Figure 6-D



### IMPORTANT NOTE:

There should always be a 0.016" gap between the neck body and the datum block (see Figure 6-D) when the neck is properly installed.

If the rear stop was removed to close this gap, **it must be reinstalled!**

The rear stop should only be removed to clean debris from inside the block and then immediately reinstalled.

**Never operate the fixture without the rear stop installed.**



# SECTION 7 — PARTS LIST

---

## 7-1 Checking Fixture Parts List

Component	Air-Cooled Neck	TOUGH GUN I.C.E. Neck
Checking Fixture	G-405CA	G-405CA
Datum Block	G-405-4*	G-405-4*
Gauge Pointer	G-495-8*	G-495-8*
Neck Alignment Kit for Special Necks	GS-101*	GS-101* and G-495-8*

\* Included with G-405CA checking fixture.

## 7-2 Common Parts to All Checking Fixtures

Part Number	Description
G-405-3	Checking pin block assembly (includes the G-495-3 checking pin); for all gauges
G-495-3	Checking pin; for all gauges
G-495-6	Gauge bending handle

## ADDITIONAL SUPPORT MATERIALS

---

For additional support materials such as Spec Sheets, troubleshooting information, how-to guides and videos, animations, online configurators and much more, please visit Tregaskiss. Scan the QR Code with your smart phone for immediate access to [Tregaskiss.com/TechnicalSupport](http://Tregaskiss.com/TechnicalSupport).



---

**Tregaskiss**  
2570 North Talbot Road  
Windsor, Ontario NOR 1L0  
Canada

Phone: 1-855-MIGWELD (644-9353) (US & Canada)  
+1-519-737-3000 (International)  
Fax: 1-519-737-1530



For more information, visit us at [Tregaskiss.com](http://Tregaskiss.com)

---