

Bernard® W-Gun™ MIG Guns

Issued June 2024 • Index No. WGUN/1.4

**Semi-Automatic Water-Cooled
MIG Welding Guns** 

Quick Specs

Applications

Heavy Equipment
Shipbuilding & Repair
Pipeline
Fabrication

Processes

MIG (GMAW)
Welding

Wire Size

0.030" - 3/32"
(0.08 mm - 2.4 mm)

Duty Cycle

100%: 600 amp with CO₂ Gas
100%: 600 amp with Mixed Gas

Increase Versatility and Productivity. Improve Weld Quality.

Available in 600 amp models between 8- and 25-foot cable lengths, Bernard® W-Gun™ semi-automatic water-cooled MIG guns contain a flexible cable assembly with reinforced synthetic rubber hoses to prevent water leakage, provide increased water flow and reduce gas leakage.

Heavy duty necks are available in multiple lengths and bend configurations to allow for optimal weld accessibility – plus, choose from a variety of handle and trigger options to accommodate operator comfort and preference.

- Flexible cable assembly with reinforced synthetic rubber hoses prevents water leakage and provides increased water flow and reduced gas leakage
- Multiple trigger options increase operator comfort
- Heavy duty water-cooled necks are offered in multiple length and bend configurations to allow for optimal weld accessibility and improved operator comfort
- Rear housing with water cable strain relief reduces chance of kinking and premature gun failure
- Water block with interchangeable power pins and trigger leads connects to wire feeders and machines from major manufacturers and allows for simple maintenance

Heavy duty water-cooled neck available in a variety of length and bend configurations

Choose between NEW! AccuLock™, Centerfire™ or Quik Tip™ consumables

Hang up hook for convenience

Curved handle design with multiple trigger options to choose from

Flexible cable assembly with reinforced synthetic hoses

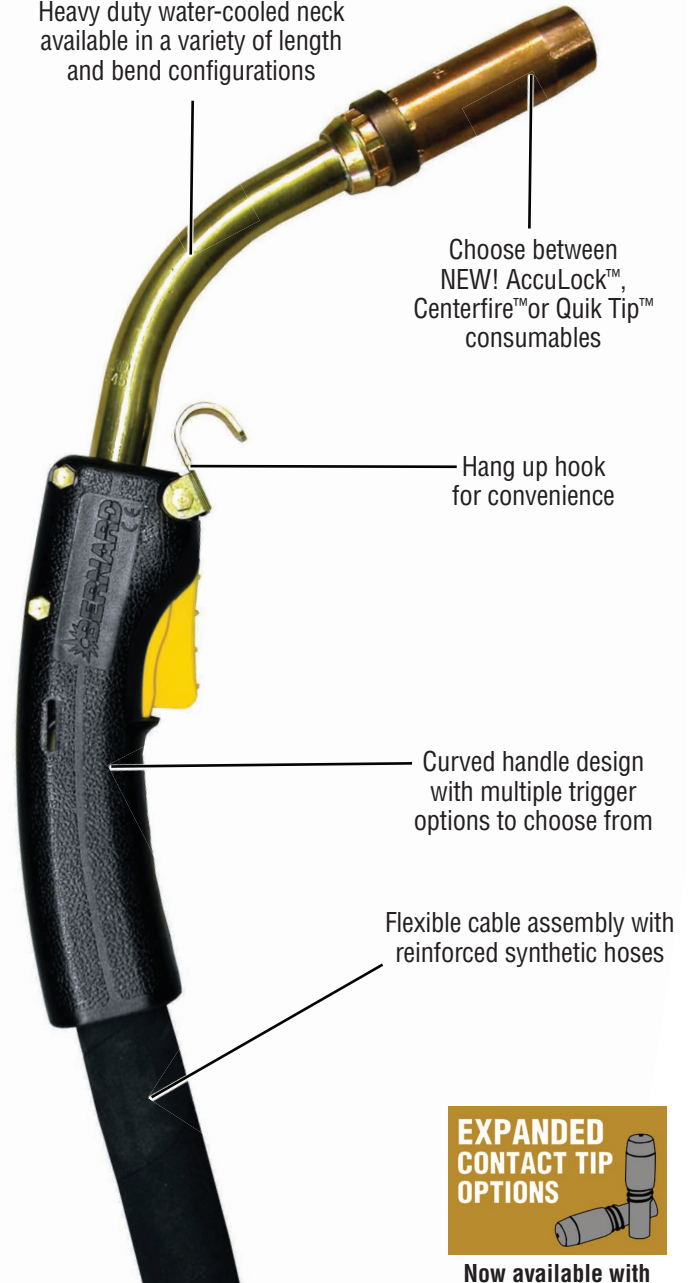

**EXPANDED
CONTACT TIP
OPTIONS**



**Now available with
new AccuLock
consumables**



Bernard

A Division of Miller Electric Mfg. LLC
449 West Corning Road
Beecher, Illinois 60401 USA

Phone: 1-855-MIGWELD (644-9353) (US & Canada Only)

+1-519-737-3000 (International)

Fax: 708-946-6726

For more information, visit us at Tregaskiss.com

Handle and Trigger Options

Handle and Trigger Kits

- 1880198** Handle kit; standard, locking, dual pull trigger
DSA-1 Handle kit; dual schedule, locking dual schedule trigger

Necks

WC2T2-30
(30° Bend)

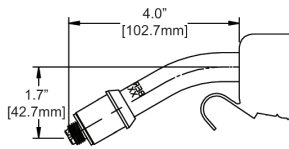

WC2T3-30
(30° Bend)

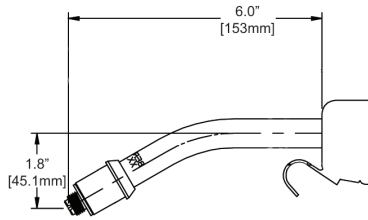

WC2T4-30
(30° Bend)

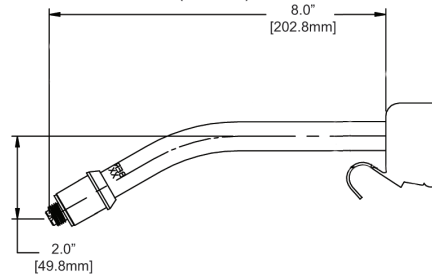

WC2T2-45
(45° Bend)

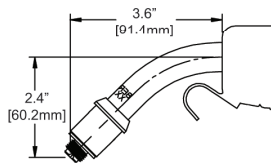

WC2T3-45
(45° Bend)

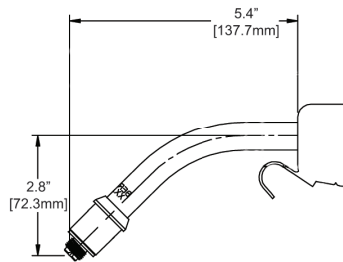

WC2T4-45
(45° Bend)

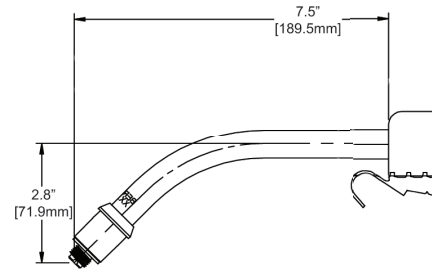

WC2T2-60
(60° Bend)

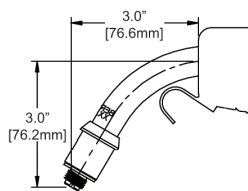

WC2T3-60
(60° Bend)

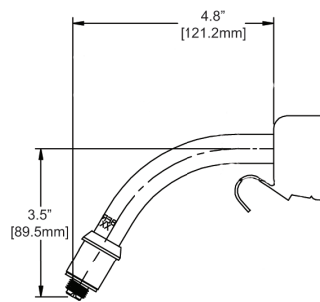

WC2T4-60
(60° Bend)

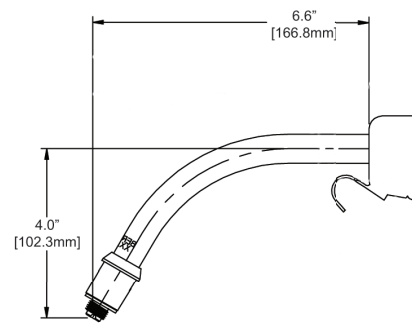

WC2T-180-6

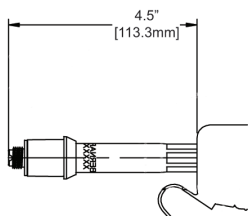

WC2T-180-8

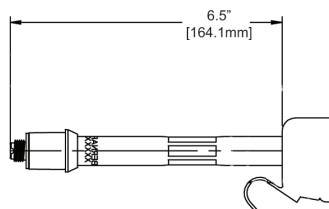

WC2T-180-10

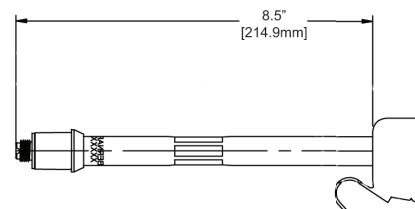

Consumables



AccuLock™ R Consumables

See AccuLock™ R Consumables Spec Sheet (SP-ALR) for more information and additional options that can be ordered separately



Contact Tips

T-A023CH 0.023" (0.6 mm)	T-A045CH 0.045" (1.2 mm)	T-A072CH 0.070" (1.8 mm)
T-A030CH 0.030" (0.8 mm)	T-A052CH 0.052" (1.3 mm)	T-A078CH 5/64" (2.0 mm)
T-A035CH 0.035" (0.9 mm)	T-A062CH 1/16" (1.6 mm)	T-A094CH 3/32" (2.4 mm)
T-A039CH 0.039" (1.0 mm)		

AccuLock R Diffusers

D-ATSH-AW2 Diffuser, water-cooled, Acculock R

Nozzles

5627 1/8" recess, water-cooled

Neck Insulators

1840003 Neck insulator

Centerfire™ Consumables

See Centerfire™ Consumables Spec Sheet (SP-CFC) for more information and additional options that can be ordered separately



Contact Tips

T-023 0.023" (0.6 mm)	T-039 0.039" (1.0 mm)	T-062 1/16" (1.6 mm)
T-030 0.030" (0.8 mm)	T-045 0.045" (1.2 mm)	T-078 5/64" (2.0 mm)
T-035 0.035" (0.9 mm)	T-052 0.052" (1.4 mm)	T-094 3/32" (2.4 mm)

Diffusers

DW-1 Diffuser, water-cooled

Nozzles

NW-3418C 1/8" recess, water-cooled
NW-3414C 1/4" recess, water-cooled

Quik Tip™ Consumables

See Quik Tip™ Consumables Spec Sheet (SP-QTC) for more information and additional options that can be ordered separately



Contact Tips

T1035 0.035" (.9 mm)
T1045 0.045" (1.2 mm)
T1364 3/64" (1.2 mm)
T1052 0.052" (1.4 mm)
T1116 1/16" (1.6 mm)

Diffusers

1070101 Diffuser, water-cooled

Nozzles

5627 1/8" recess, water-cooled

Neck Insulators

1840003 Neck insulator

Bernard Conventional Liners (rear-loading)

See Bernard Conventional Liner Spec Sheet (SP-L) for more information

10' (3.05 m) Gun Lengths

L3A-10 for 0.035" - 0.045" wire **L4A-10** for 0.045" - 1/16" wire

15' (4.57 m) Gun Lengths

L1A-15 for 0.023" - 0.030" wire **L3A-15** for 0.035" - 0.045" wire* **L6A-15** for 5/64" wire
L2A-15 for 0.030" - 0.035" wire **L4A-15** for 0.045" - 1/16" wire** **L7A-15** for 3/32" wire

25' (7.62 m) Gun Lengths

L1A-25 for 0.023" - 0.030" wire **L3A-25** for 0.035" - 0.045" wire* **L6A-25** for 5/64" wire
L2A-25 for 0.030" - 0.035" wire **L4A-25** for 0.045" - 1/16" wire** **L7A-25** for 3/32" wire

Components

Conduits

WC2CA-6	Conduit assembly, 8 ft (2.44 m)	WC2CA-3	Conduit assembly, 15 ft (4.57 m)
WC2CA-1	Conduit assembly, 10 ft (3.05 m)	WC2CA-4	Conduit assembly, 20 ft (6.10 m)
WC2CA-2	Conduit assembly, 12 ft (3.66 m)	WC2CA-5	Conduit assembly, 25 ft (7.62 m)

Return Hoses

RRH-08	Return hose, 8 ft (2.44 m)	RRH-15	Return hose, 15 ft (4.57 m)
RRH-10	Return hose, 10 ft (3.05 m)	RRH-20	Return hose, 20 ft (6.10 m)
RRH-12	Return hose, 12 ft (3.66 m)	RRH-25	Return hose, 25 ft (7.62 m)

Power Cables

RPC-08	Power cable, 8 ft (2.44 m)	RPC-15	Power cable, 15 ft (4.57 m)
RPC-10	Power cable, 10 ft (3.05 m)	RPC-20	Power cable, 20 ft (6.10 m)
RPC-12	Power cable, 12 ft (3.66 m)	RPC-25	Power cable, 25 ft (7.62 m)

Return Hose/Power Cable Sets *(includes return hose and power cable)*

RCS-08	Return hose/power cable set, 8 ft (2.44 m)	RCS-15	Return hose/power cable set, 15 ft (4.57 m)
RCS-10	Return hose/power cable set, 10 ft (3.05 m)	RCS-20	Return hose/power cable set, 20 ft (6.10 m)
RCS-12	Return hose/power cable set, 12 ft (3.66 m)	RCS-25	Return hose/power cable set, 25 ft (7.62 m)

Control Wire Assemblies

WC2CW-4	Control wire assembly, 8 ft (2.44 m)	WC2CW-3	Control wire assembly, 15 ft (4.57 m)
WC2CW-1	Control wire assembly, 10 ft (3.05 m)	WC2CW-5	Control wire assembly, 20 ft (6.10 m)
WC2CW-2	Control wire assembly, 12 ft (3.66 m)	WC2CW-6	Control wire assembly, 25 ft (7.62 m)

Outer Covers

WC2OC-08	Outer cover, 8 ft (2.44 m)	WC2OC-15	Outer cover, 15 ft (4.57 m)
WC2OC-10	Outer cover, 10 ft (3.05 m)	WC2OC-20	Outer cover, 20 ft (6.10 m)
WC2OC-12	Outer cover, 12 ft (3.66 m)	WC2OC-25	Outer cover, 25 ft (7.62 m)

Cable Assemblies *(includes conduit, return hose, power cable, control wire and outer cover)*

RCA-08	Cable assembly, 8 ft (2.44 m)	RCA-15	Cable assembly, 15 ft (4.57 m)
RCA-10	Cable assembly, 10 ft (3.05 m)	RCA-20	Cable assembly, 20 ft (6.10 m)
RCA-12	Cable assembly, 12 ft (3.66 m)	RCA-25	Cable assembly, 25 ft (7.62 m)

Power Pins

Bernard®

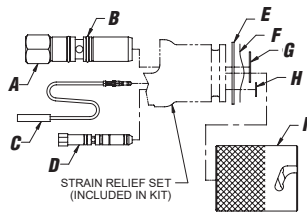

A.	Power Pin Assembly	2200008
B.	O-Ring (2 Required)	4929
C.	Lead Wire (2 Required)	4924
D.	Gas Pin Assembly	2060033
E.	Snap Ring, Large	4911
F.	Wave Ring	4916
G.	Snap Ring, Medium	4912
H.	Snap Ring, Small	2250016
I.	Locking Sleeve	4925

Tweco® #4 / #5

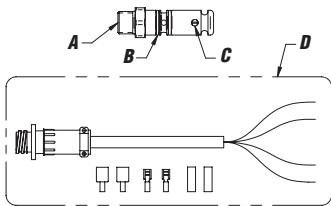

A.	Power Pin Assembly (Tweco 4)	2200118
	Power Pin Assembly (Tweco 5)	2200104
B.	O-Ring (2 Req'd - Tweco 4)	4713
	O-Ring (2 Req'd - Tweco 5)	4929
C.	Set Screw	4714
D.	Trigger Cable Adaptor	SCT1N
	Trigger Cable Adaptor, Lincoln*	SCL2N
	Trigger Cable Adaptor, ESAB*	SCX1N

*Optional

Lincoln®

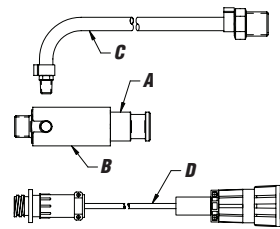

A.	Power Pin	2200099
B.	Insulator	1840059
C.	Gas Line Assembly	GLM1
D.	Trigger Cable Adaptor	SCL2N

Euro

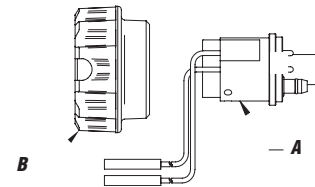

A.	Euro Block Assembly	5060
B.	Adaptor Nut	4816

Miller®

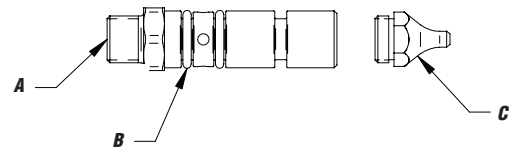

A.	Power Pin Assembly (Includes O-Rings)	2200101
B.	O-Ring (2 Required)	4478
C.	Power Pin Tip (0.023" - 0.045")	4477
	Power Pin Tip (3/32" - 1/8")	4474
	Power Pin Tip (0.052" - 5/64")*	4477-564
<i>Power Pin Tips for Aluminum Wire</i>		
	Power Pin Tip (0.030" - 0.035")*	2200105
	Power Pin Tip (0.040" - 3/64")*	2200106
	Power Pin Tip (0.052" - 1/16")*	2200107

*Optional

Ordering Information

Amperage	Cable Length	Handle and Trigger	Neck	Contact Tip	Wire Size	Power Pin
W 60	15	A	I	4	C	M
W60 600 amp	08 8 ft (2.44 m)	A Standard trigger	A Short, 30°	4 AccuLock™ R	B 0.030"	B Bernard®
	10 10 ft (3.05 m)	B Locking trigger	B Short, 45°	8 Centerfire™	C 0.035"	E Euro
	12 12 ft (3.66 m)	C Dual pull trigger	C Short, 60°	5 Quik Tip™	D 0.039" [^]	L Lincoln®
	15 15 ft (4.57 m)	D Dual schedule switch	D Short, 180°		E 0.045"	M Miller®
	20 20 ft (6.16 m)	E Locking dual schedule switch	H Medium, 30°		H 0.052"	N National®
	25 25 ft (7.63 m)		I Medium, 45°		I 1/16"	O OXO™
			J Medium, 60°		K 5/64"	S Tweco® #4 (Lincoln lead)
			K Medium, 180°		L 3/32" <u>Aluminum*</u>	T Tweco #4 (standard lead)
			P Long, 30°		Q 0.035"	U Tweco #5 (two-prong twist-lock lead)
			Q Long, 45°		R 3/64"	W Tweco #5 (standard lead)
			R Long, 60°		S 1/16"	
			S Long, 180°			

* Not compatible with AccuLock Contact Tip option

[^] Not compatible with Quik Tip Contact Tip option

Brand and product names shown above are trademarks of their respective owners.

Subject to Change – The information presented in this spec sheet is accurate to the best of our knowledge at the time of printing. Please visit Tregaskiss.com for the most up-to-date information.

Distributed By:

